

F 2084 NBR

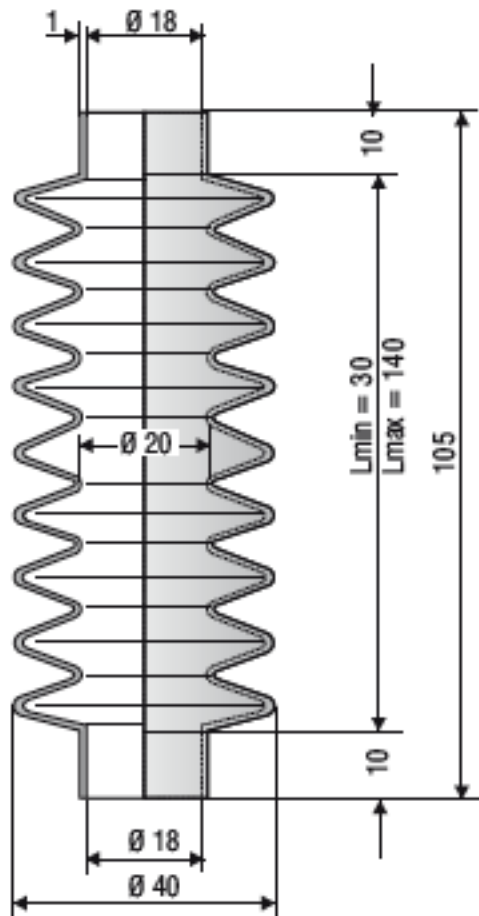

F 1510 NBR

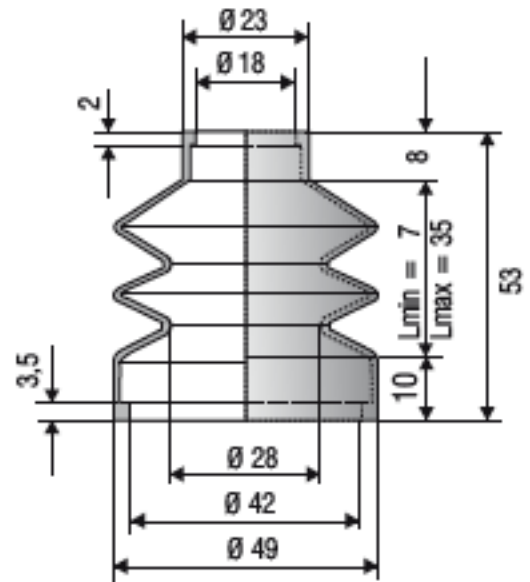

F 1038 NBR

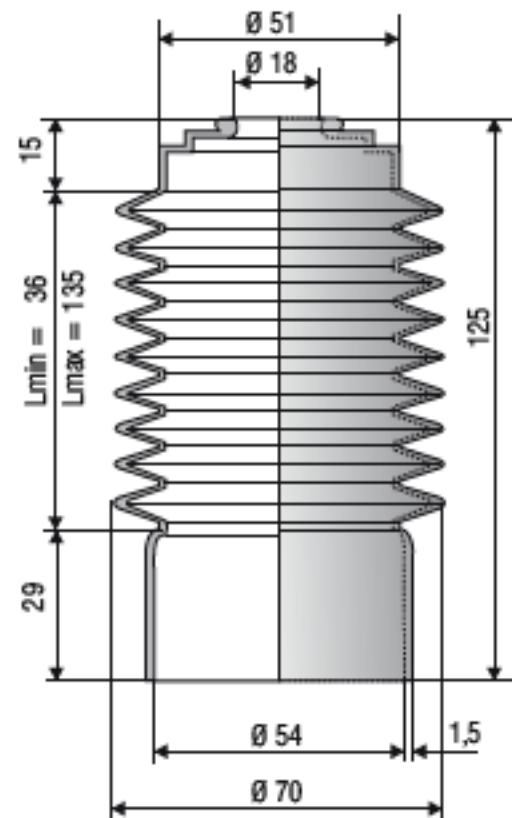

F 1144 NBR

