

F 3047 NBR

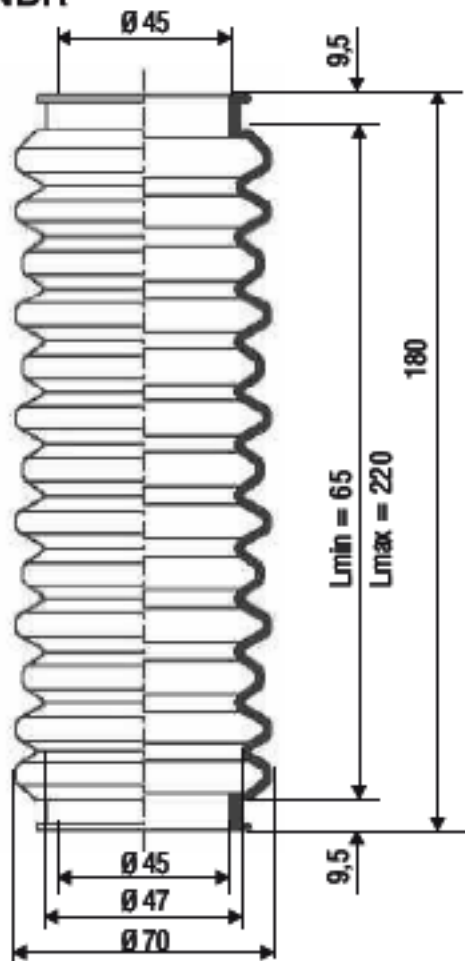

F 1223 NBR

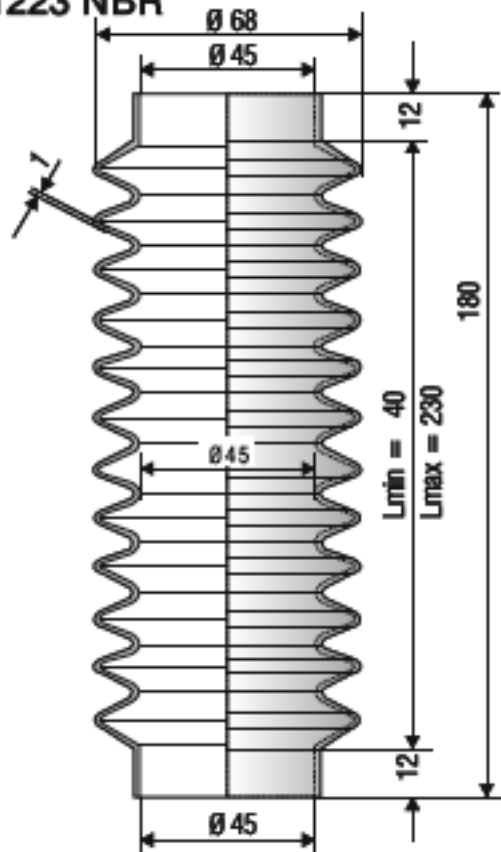

F 1523 NBR

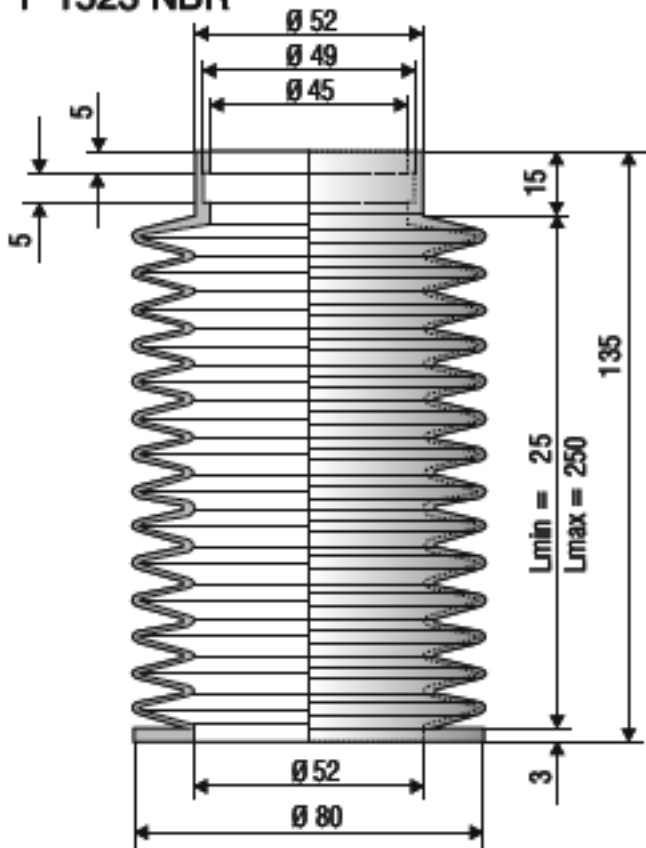

F 1229 NBR

