

F 1055 NBR

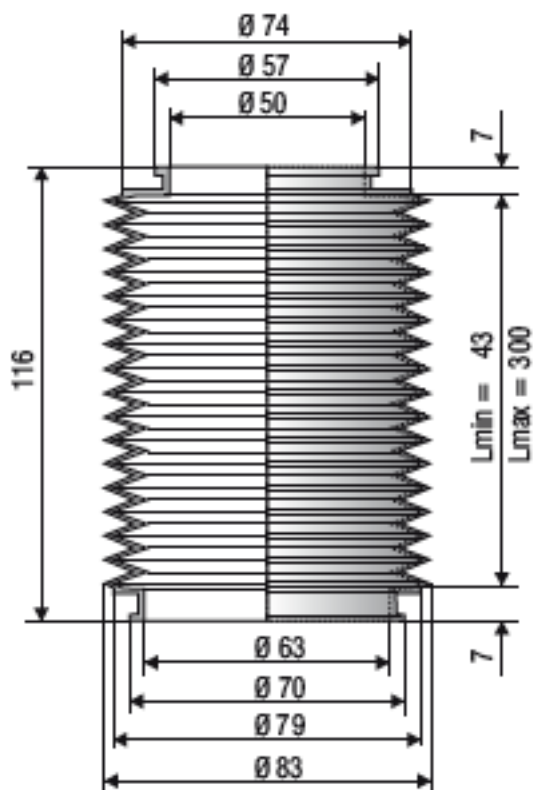

F 1245 NBR

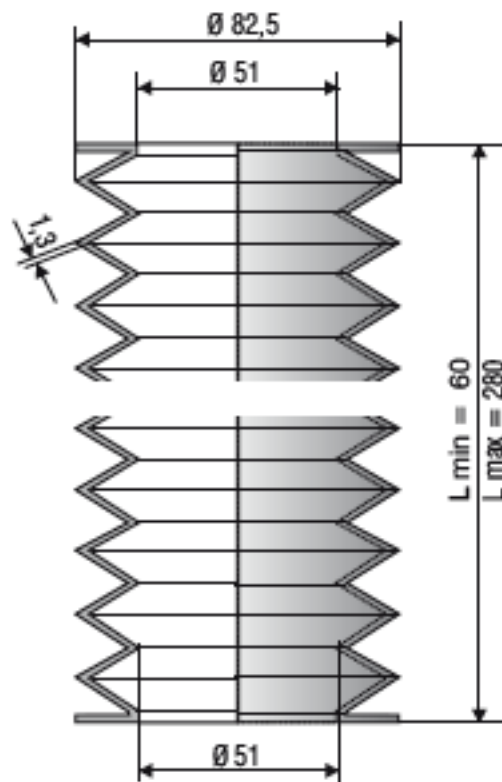

F 1191 NBR

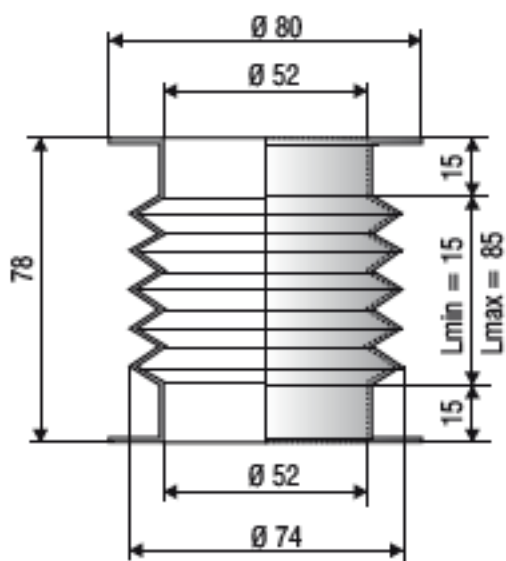

F 2015 NBR

