

F 1205 NBR

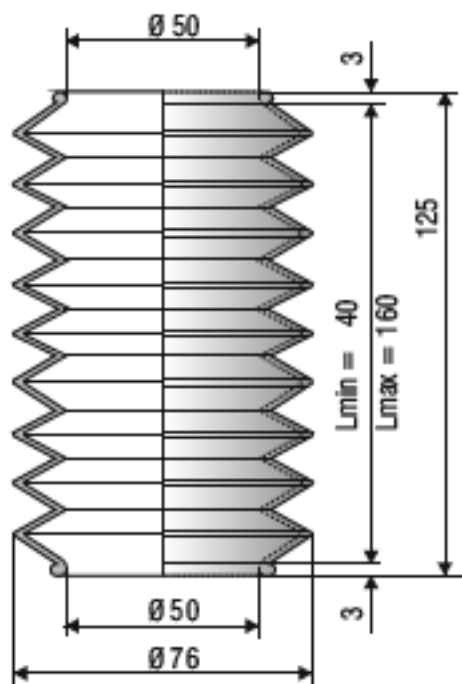

F 1112 NBR

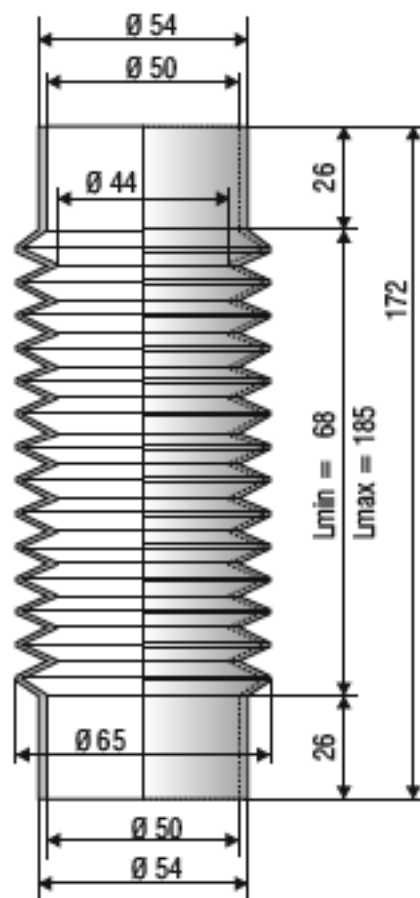

F 1141 NBR

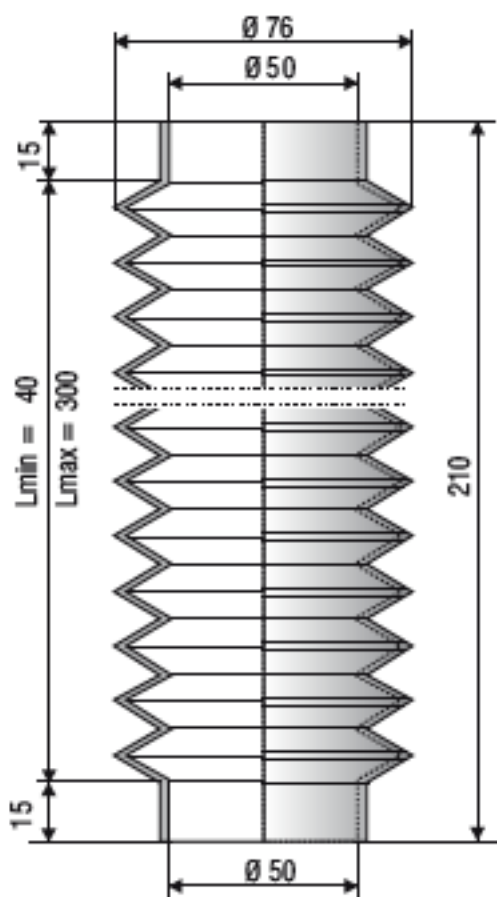

F 1208 Si

